



Divan d'examen bariatrique
Gamme OVALIA-MAX
OVALIA-MAX

CARINA
Medical



CE
ISO 9001
ISO 13485

DESCRIPTION TECHNIQUE

- Divan d'examen à hauteur variable électrique bariatrique, 2 parties
- Commande : Télécommande manuelle multifonctions
- Tête réglable par vérin électrique
- Sellerie tendue plate de bonne densité 40kg/cm² (**haute résistance**), non-feu classée M1, épaisseur 10cm
- Equipé d'un porte-rouleau pour drap d'examen côté tête
- Piètement acier peint époxy, coloris sable
- Sur 4 roulettes escamotables diam. 35mm pour un déplacement du divan à vide

DIMENSIONS

- Largeur 90cm
- Hauteur variable de 50 à 90cm
- Capacité de charge : 380kg en dynamique

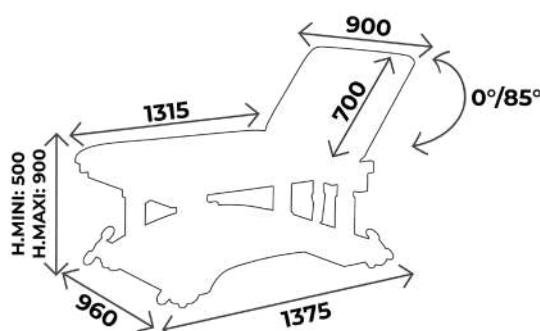

À SAVOIR

- ✓ Délai : 15 jours à réception commande
- ✓ Garantie : 5 ans (1 an pour la sellerie)

ACCESSOIRES

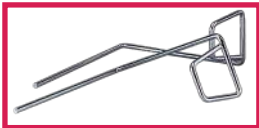

ACC 105
Jeu d'étriers inox standard
diam. 14mm, sans étai



SLFEMIREPOSE
Housse prélude pour repose
jambes (ACC964), l'unité



ACC 110
Gouttière prise de sang
Avec ferrure, sans étai, l'unité



ACC BARRILITOV09
Paire de barrières escamotables
Pour divan largeur 90cm



ACC TETERGO
Tête ergonomique amovible



ACC 964
Jeu de repose jambes noir,
sur rotule mousse polyuréthane,
diam. 14mm, sans étai



ACC 514-UNIVERSE
Protection plastique transparent
universelle



ACC 110POLY
Gouttière prise de sang
polyuréthane avec ferrure
Sans étai, l'unité



ACC BATTERIE01
Batterie autonomie de 20 cycles
(1 cycle = une montée/ descente
+ une montée/ descente
de dossier)



ACC 76-OVALIAMAX
Jeu d'étraux
pour fixation accessoires (étriers,
repose jambes...)

COLORIS SELLERIE

Sellerie non-feu
classée M1

Pour les coloris de sellerie, vous avez le choix entre la gamme Classique et Urban
Attention ! coloris Urban **avec plus value**

Revêtement : Sellerie Gamme Classique



Arno



Garonne



Potomac



Amour



Mississippi

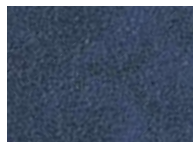

St Laurent

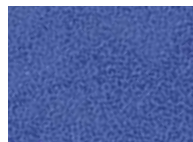

Rhône



Missouri



Seine



Amazone

Revêtement : Sellerie Gamme Urban



Abysse

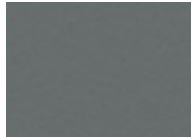

Cendre



Origan



Géranium



Réglisse



Prune

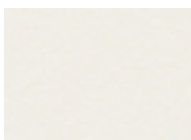

Perle

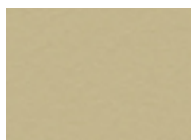

Ficelle

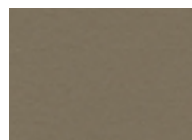

Terre

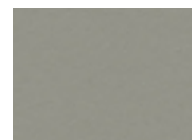

Béton

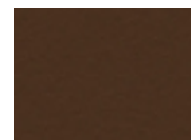

Chataigne

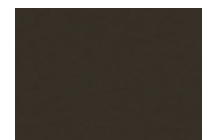

Chocolat

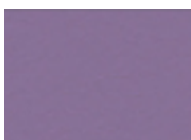

Pensée



Pétrole



Turquoise



Granny



Absinthe



Ananas



Orange



Fuschia



Tomate

COLORIS PIÈTEMENT

Toute la gamme OVALIA-MAX est proposée en coloris sable en standard
Possibilité de changer le coloris de capot **sans plus value**

Piètement Peinture EPOXY

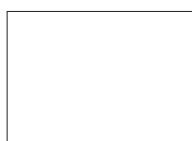

RAL 9003

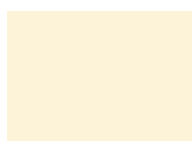

RAL 1013

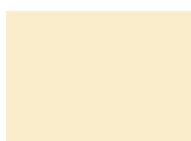

RAL 1015



RAL 6019



RAL 6033



RAL 6000



RAL 5017



RAL 5002



RAL 5000



RAL 7035



RAL 7016



RAL 9005



RAL 1018



RAL 3020



RAL 3003

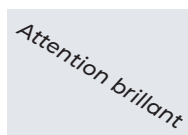

ARGENT



GUIDE D'ENTRETIEN

ENTRETIEN QUOTIDIEN

- Sellerie : nettoyage à l'eau savonneuse uniquement (solvants proscrits), peut être désinfecté avec des produits tels que Phagosept Spray, Salvanios pH10 à 0,75% et Anios Surfaces Hautes, sans matière abrasive
- Piètement : nettoyage à l'eau savonneuse uniquement (solvants proscrits) sans matière abrasive

GARANTIE

- Châssis : 5 ans
- Sellerie : 1 an



CONTACT

CARINA
Médical

Parc d'entreprises Visionis
278 rue de l'industrie
01090 GUÉREINS- FRANCE

SERVICE COMMERCIAL

Tél : +33(0)4 74 66 69 49
Fax : +33(0)4 74 66 69 50
commercial@carinamedical.com